

RS2^{x2}

With you on the front line

**Quick Start
and User Manual**

V 1.4.1

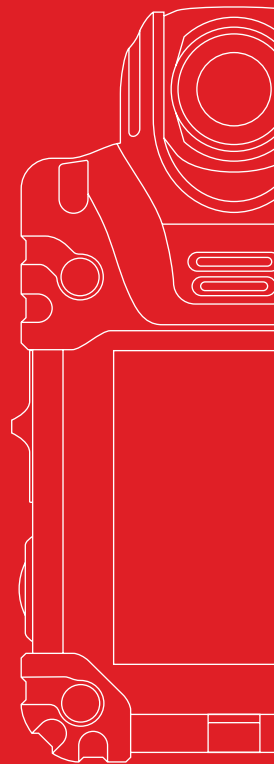

Quick start

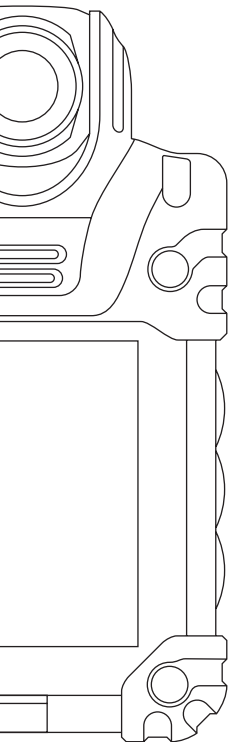

1 Charge

Charge the camera for four hours or until the charging light turns green.

2 Mount

Choose how to mount your camera; you can use either the Klickfast attachments, clips or a lanyard.

3 Record

Slide the red switch down to start recording. To stop recording, slide the red switch up.

Quick start

1 Charge

Open the cover on the bottom of the camera and insert into a Reveal docking station. Alternatively, connect to the USB cable.

You can use any USB wall charger which supplies 0.5A or more on the USB port. Connecting the camera to any computer USB port will charge the camera.

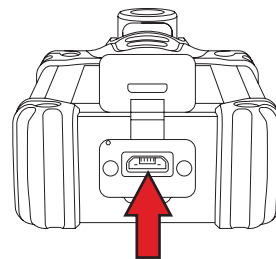

NOTE: Please take care when connecting and disconnecting the USB cable.

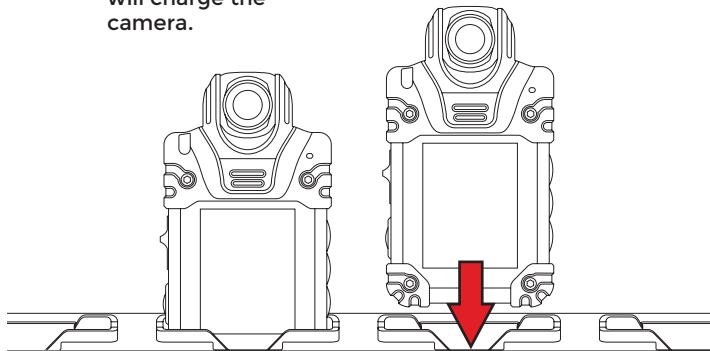

Quick start

2 Mount

Choose your mount:

- Klickfast stud
- Angled Klickfast stud (for use with a high mounting position)
- Shirt clip (adjustable for male and female shirts)
- Pocket clip (for use with lanyard)

Align the mount on the back of the camera and use the screw to secure.

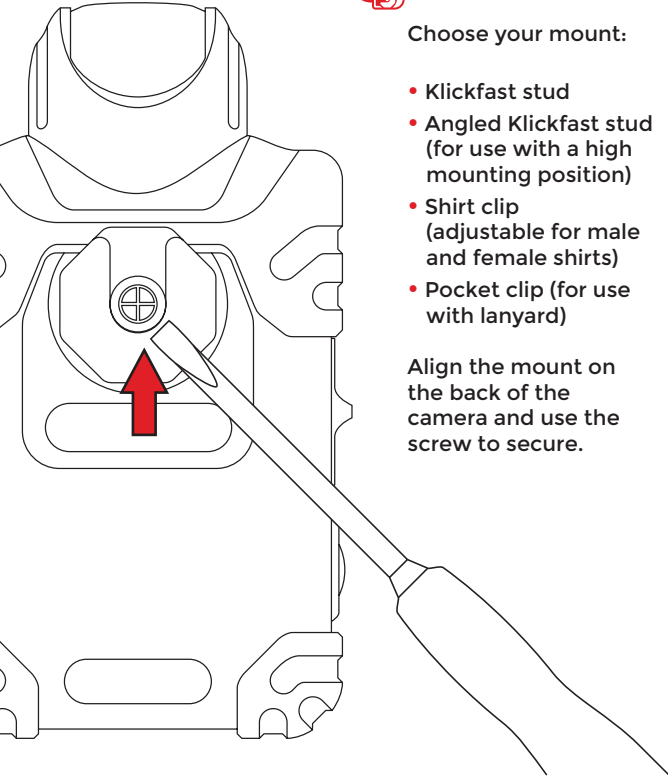

Quick start

3 Record

Slide down the red switch to start recording.

NOTE: The unit does not need to be powered on to start recording, recording will be activated anytime the record switch is activated.

As confirmation:

- The camera will beep three times.
- The LED and the recording icon on the screen will flash red.

Slide the switch back up to stop recording.

As confirmation:

- The camera will beep twice.
- The lights will stop flashing.

NOTE: To enable a double confirmation action to stop recording, see *'Optional camera settings'*, page 13.

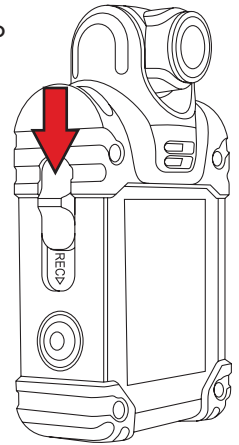

Operation

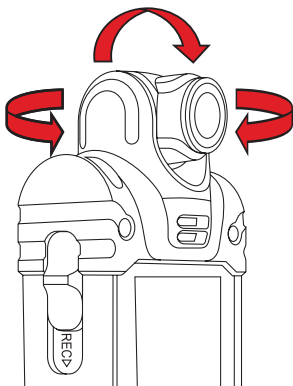

Camera articulation

CAUTION:
DO NOT OVER ROTATE!

The camera head does not rotate 360°. Forcing it will cause damage to the camera head.

Power on/off

When the unit is off, press the **FUNCTION** button to turn power on and open preview mode.

Preview mode allows you to orientate the lens, enter playback mode and view settings.

Press and hold the **FUNCTION** button for longer than 2 seconds to turn power off.

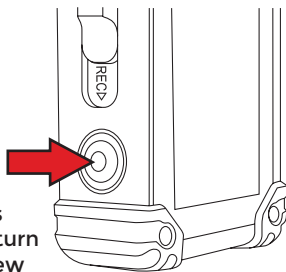

NOTE: The unit has a power saving feature which automatically switches the unit off after two minutes if no activity is detected.

Operation

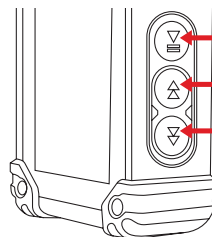

 **PLAY / PAUSE VIDEO**

 **REWIND / SCROLL THROUGH VIDEOS**

 **FAST FORWARD / SCROLL THROUGH VIDEOS**

Onboard playback

Press the **FUNCTION** button to turn the camera on.

Once on, press the **PLAY** button to open playback mode.

NOTE: If encryption is activated you will need to enter your encryption pin for playback. See '**Activating AES-256 bit encryption**', page 14-15.

Show menu options

In preview mode, press and hold **FWD** and **RWD** simultaneously to bring up menu screen. Use **FWD** and **RWD** buttons to scroll through menu options and press **PLAY** button to view chosen setting.

NOTE: Menu options can only be changed via a PC. See '**Optional camera settings**'; page 10.

Stealth mode

Stealth mode enables recording without the front facing screen or LED light being active.

Hold **RWD** button for three seconds to activate or deactivate stealth mode.

Function button

Go back

Press the **FUNCTION** button once to go back on the menu screen and in playback mode.

Press the **FUNCTION** button twice to exit the ENTER PIN screen and go back to preview mode.

Mark as important

While recording: press the **FUNCTION** button once to mark the video as important.

The  symbol will appear in the bottom right corner of the screen.

In playback mode: Select the desired thumbnail. Press and hold the **FUNCTION** button for 2 seconds to mark video as important.

The  symbol will appear in the bottom right corner of the thumbnail.

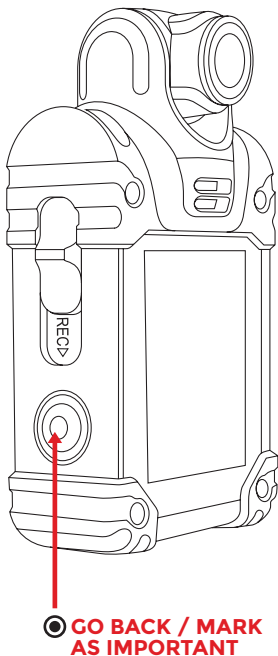

LED light indicators

During normal operation

Power on
Solid red light

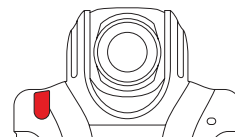

Recording
Flashing red light

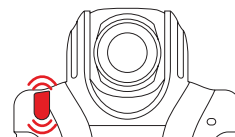

When connected via USB

Charging
Solid blue light

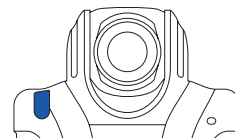

Fully charged
Solid green light

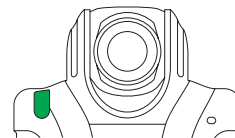

Optional camera settings

Through DEMS

In the administration window select the 'Reveal camera settings' tab.

NOTE: Requires DEMS V3.5 or later.

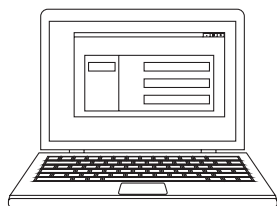
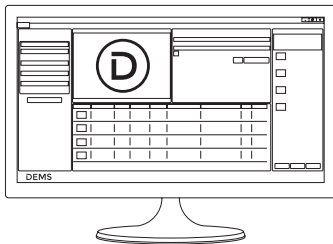

Without DEMS

NOTE: You must run the Reveal Camera Manager as an administrator to change the camera settings.

- 1) Download the Reveal Camera Manager from www.revealmedia.com/downloads
- 2) Run the program on the computer.
- 3) Select which camera you want to edit from the list on the left and edit the options on the right.

Optional camera settings

Resetting your camera

Occasionally your device may require resetting.

The camera provides a pin hole reset button which is activated by inserting a pin or paperclip into the hole shown below.

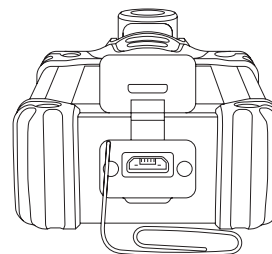

Simply insert the paperclip or pin momentarily to reset your camera.

After resetting, simply power the camera up using the off/on button or the record switch.



Optional camera settings

1. RESOLUTION	1920x1080 30FPS
	1280x720 30FPS (Default)
	848x480 30FPS
	640x480 30FPS
2. PRE-RECORDING Stores 30 seconds prior to record activation.	On
	Off (Default)
3. AUDIO ALARMS	On (Default)
	Off
4. WHITE BALANCE	Auto (Default)
	Sunny / Cloudy / Fluorescent/Incandescent
5. LANGUAGE	English (Default)
6. TIME AND DATE STAMP	On (Default)
	Off
7. TIME AND DATE SETUP	Set YYYY/MM/DD HR/MIN/SEC
8. START IN STEALTH MODE	On
	Off (Default)

Optional camera settings

9. AUTO LCD OFF	30 SECS / 2 MINS / 5 MINS / Off (Default)
10. DEFAULT SETTINGS Resets camera to default settings.	No / Yes
11. UNIT ID SETUP	User set (five alphanumerics)
12. PRE-RECORD MUTE No audio is recorded during the pre-record section of video. Once the user switches on record mode, audio is then recorded.	On
	Off (Default)
13. PROTECTED MODE With protected mode enabled the camera is seen as a mass storage device on your computer and video files can be accessed and copied, but videos cannot be played without DEMS or Reveal Camera Manager.	On
	Off (Default)
14. TRUSTED MODE With trusted mode enabled the camera is seen as a removable disk on your computer, but if you try to access the disk, windows will report there is no disk in the drive and no data from the camera can be accessed without DEMS or Reveal Camera Manager.	On
	Off (Default)
15. RECORD OFF MODE For single or two actions to stop recording.	Slider only (Default)
	Slider plus power button
16. FIRMWARE VERSION	Displays the version of firmware installed on the device.

Activating AES-256 bit encryption

Through DEMS

Log in to DEMS as administrator.

Navigate to Reveal camera encryption tab in the Administration window under the Advanced menu.

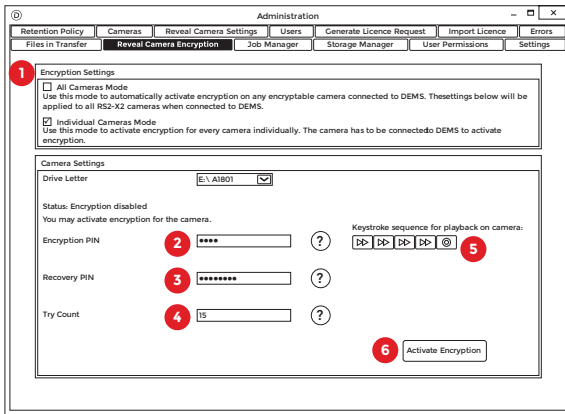

IMPORTANT NOTE: Protected mode must be turned off in the settings on each Reveal camera before encryption is activated, otherwise videos will be corrupted.

Activating encryption

- 1 Encryption settings:** Choose between activating encryption automatically for all cameras when connected to DEMS using the same encryption PIN or activating each camera individually using a different encryption PIN.
- 2 Encryption PIN:** Enter 4 to 8 digits. Use this to enable playback of videos on the camera. This will automatically generate a keystroke sequence.
- 3 Recovery PIN:** Enter 8 to 20 digits. Use this to deactivate encryption on the camera. This is required to recover the camera if the number of failed attempts to decrypt the camera has been exceeded.
- 4 Try count:** Enter a value between 3 and 15. This value indicates the number of failed attempts to decrypt the camera before it is blocked.
- 5 Keystroke sequence:** Shows the order of button presses that you will need to enter on the camera to enable playback of encrypted videos.
- 6 Activate encryption:** Click this to activate encryption with the settings you have entered followed by clicking OK in the confirmation pop-up window.

Through Reveal Camera Manager

Although the layout of the settings will vary, please note encryption is activated by following the same steps as in DEMS.

Deactivating AES-256 bit encryption

Through DEMS

Log in to DEMS as administrator.

Navigate to Reveal camera encryption tab in the Administration window under the Advanced menu.

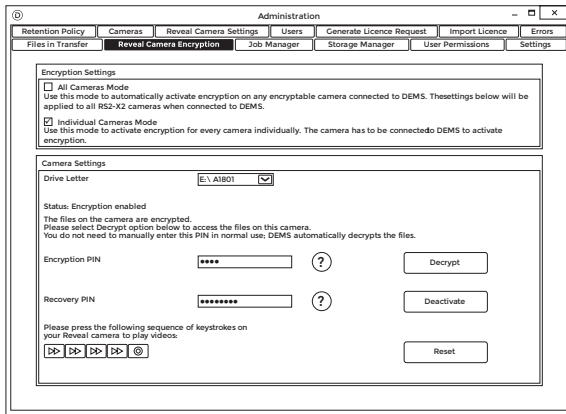

Deactivating encryption

FOR INDIVIDUAL CAMERAS MODE

Connect the camera you want to deactivate encryption on.

Enter recovery PIN and click 'Deactivate'.

NOTE: The camera should now operate as normal without encryption.

FOR ALL CAMERAS MODE

Deselect the checkbox for 'All Cameras Mode' for activating encryption automatically or simply select the other encryption option.

Connect all of the cameras you would like to deactivate encryption on to DEMS.

NOTE: The cameras should all now operate as normal without encryption.

Through Reveal Camera Manager

Although the layout of the settings will vary, please note encryption is deactivated by following the same steps as in DEMS.

Mounting and usage options

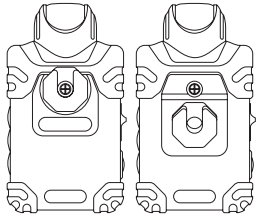

Klickfast

Standard or angled. Use the angled Klickfast when using a high mounting position.

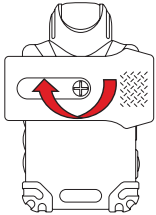

Shirt clip

For use on a shirt (adjustable for male and female shirts).

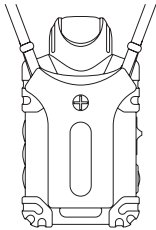

Pocket clip

For use with a lanyard around the neck or attached to a pocket.

Mounting and usage options

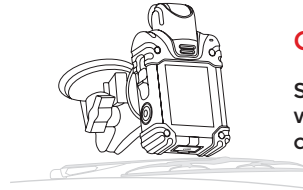

Car mount

Suction cup is attached to windscreen for in-car camera. (optional extra)



Shoulder mounts

- Harnesses
- Epaulette mount
- Shoulder mount

For use with loose fitted clothes or with shirted uniforms. (optional extra)

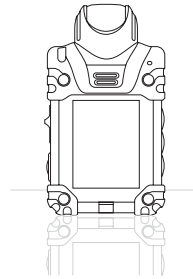

Table top

For use in interviews and other static situations.

Clickfast attachment and detachment

Attachment

Insert the Clickfast stud on the camera into the dock. Push down until the stud has clicked in and cannot be pulled out.

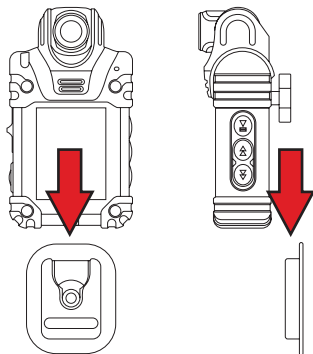

Detachment

Rotate the camera anti-clockwise or clockwise until the camera is upside down. Then pull upwards to remove the camera.

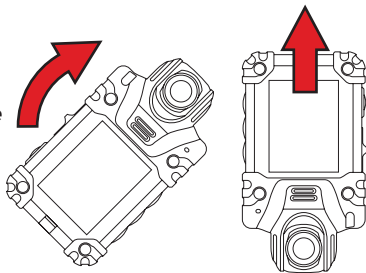

Notes



Notes

Notes

